



Product Type: Heavy-duty Connector Housing

Product Name: S10A-SM-1L.M-PG21-PC

Product Description: S10A Housings, metal, 1 levers, surface mounting, PG21 thread, plastic cover

Product Size

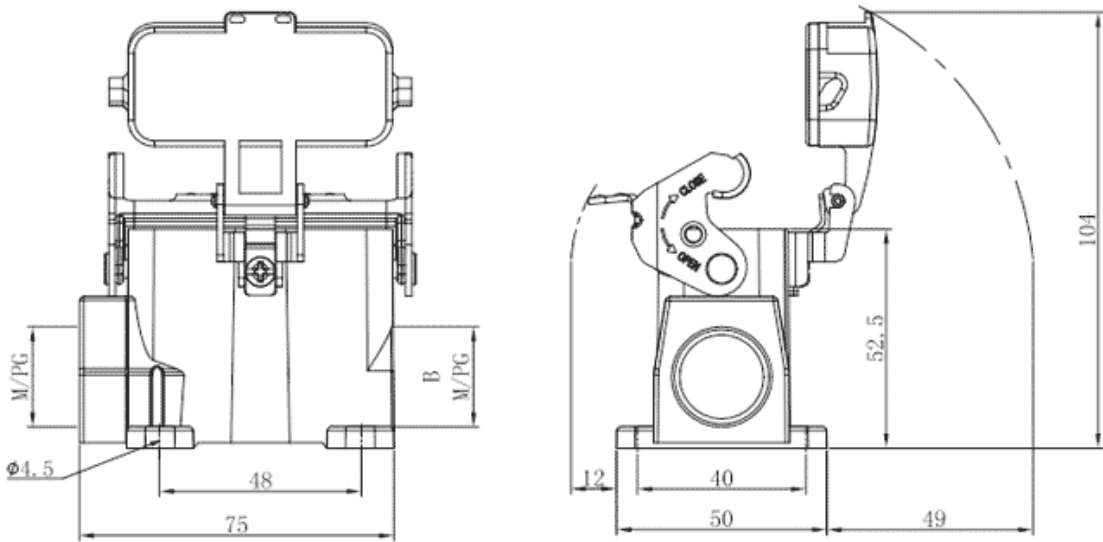

Parameters

⌘ SUPU ID	S10A-SM-1L.M-PG21-PC
⌘ Protection Level	IP65
⌘ Operating temperature range	-40°C~+125°C
⌘ Color	Grey

☞ Thread type	PG21
☞ Category	Base
☞ Mechanical endurance	≥500

Technical data

☞ Sealing material	NBR
☞ Housing Material	Die-Cast Aluminum

Commercial data

☞ Order No	S10A-SM-1L.M-PG21-PC
☞ Packing unit	PCS
☞ Minimum order quantity	1

Ningbo SUPU Electronics Co., Ltd.

Address: No. 150, Xinxing 4th Road, High-tech Industrial Development Zone,

Cixi City, Zhejiang Province, China

Zip code: 315303

Switchboard: +86 574-63288158

Fax: +86 574-63288170

E-mail: supucontact@supu.cn

Service Hotline: 400-626-6336



Wechat

Date:2026-04-27 02:17

The right to modify data belongs to SUPU.