



Product Type: Heavy-duty Connector Housing

Product Name: S16A-SEH-2B-PG21

Product Description: S16A Hoods, side entry, high construction, 2 bolts, PG21 thread

**Product Size**

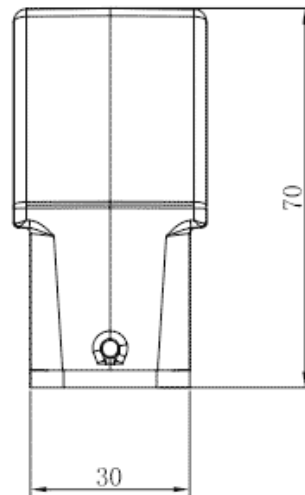
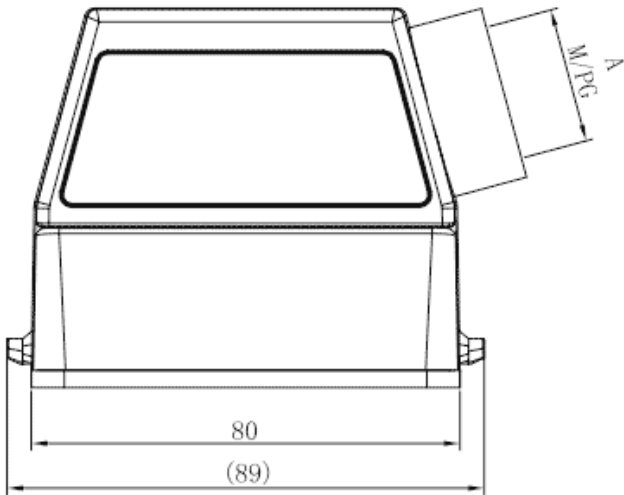

**Parameters**

⌘ SUPU ID	S16A-SEH-2B-PG21
⌘ Protection Level	IP65
⌘ Operating temperature range	-40°C~+125°C
⌘ Color	Grey

☞ Thread type	PG21
☞ Category	Housing
☞ Mechanical endurance	≥500

### Technical data

☞ Sealing material	NBR
☞ Housing Material	Die-Cast Aluminum

### Commercial data

☞ Order No	S16A-SEH-2B-PG21
☞ Packing unit	PCS
☞ Minimum order quantity	1

## Ningbo SUPU Electronics Co., Ltd.

Address: No. 150, Xinxing 4th Road, High-tech Industrial Development Zone,

Cixi City, Zhejiang Province, China

Zip code: 315303

Switchboard: +86 574-63288158

Fax: +86 574-63288170

E-mail: [supucontact@supu.cn](mailto:supucontact@supu.cn)

Service Hotline: 400-626-6336



Wechat

---

Date:2026-04-27 02:51

The right to modify data belongs to SUPU.