

Product Type: M8 Panel Mounting Connector

Product Name: M8A08C-MFHA-UC0.5

Product Description: M12A panel male 8-core ,front mounted, M8\*0.5, with 0.5 m electronic wire

Product Size

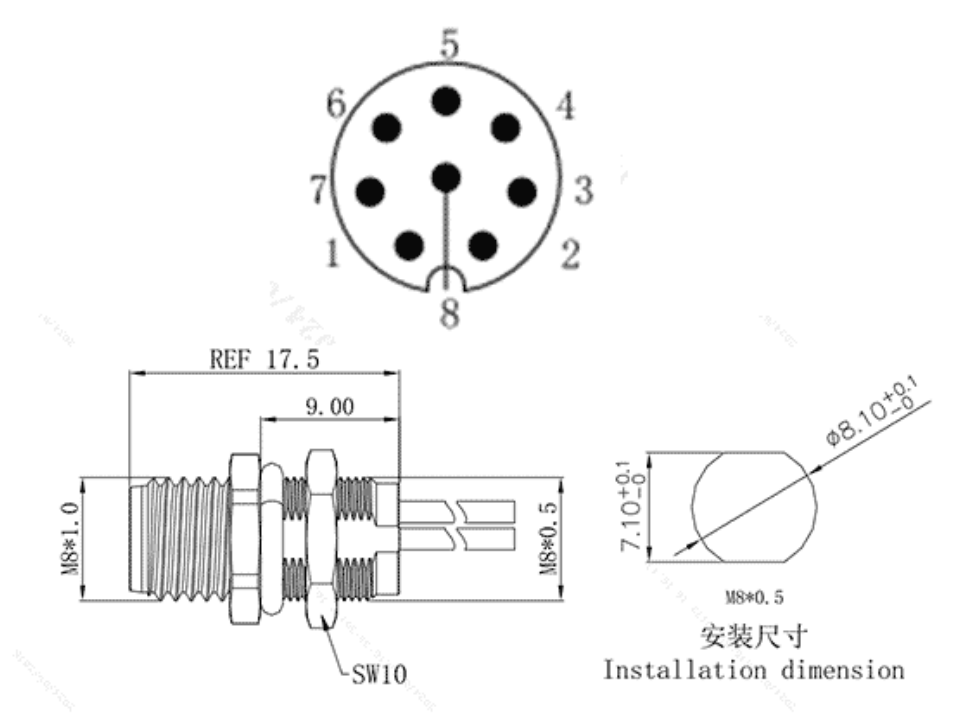

Parameters

☞ SUPU ID	M8
☞ Number of connections	8
☞ Protection Level	IP67
☞ Operating temperature range	-40~+85°C

☞ Mounting Type	Front Panel Mount
☞ Color	Black
☞ Core number	8
☞ Thread type	M8X0.5
☞ Category	Male
☞ Product type	A
☞ Coding	A
☞ Connection method	Cup Port
☞ Mechanical endurance	100
☞ Standards	IEC61076-2-104

## Technical data

☞ IEC Rated Current	1.5A
☞ IEC Rated Voltage	30 VAC / 30 VDC
☞ Degree of pollution	3
☞ Insulation Resistance	≥100MΩ
☞ Contact resistance	<10mΩ
☞ Contact/surface material	CuSn/Ni/Au
☞ Contact carrier material	PA
☞ Screw/nut material	CuZn
☞ Sealing material	NBR
☞ Cable length	0.5
☞ 导线材料	PVC

## Commercial data

☞ Order No

M8A08C-MFHA-UC0.5

☞ Packing unit

PCS

☞ Minimum order quantity

1

## Ningbo SUPU Electronics Co., Ltd.

Address: No. 150, Xinxing 4th Road, High-tech Industrial Development Zone,

Cixi City, Zhejiang Province, China

Zip code: 315303

Switchboard: +86 574-63288158

Fax: +86 574-63288170

E-mail:supucontact@supu.cn

Service Hotline: 400-626-6336



Wechat

---

Date:2026-04-26 17:58

The right to modify data belongs to SUPU.