

Product Type: Screw terminal

Product Name: TU240-2-GY

Product Description: Connection method: Screw connection, IEC Rated current: 415A, IEC Rated Voltage: 1000V, Number of connections: 2, Number of levels : 1, Rated cross section: 2/0-500kcmil

Product Size

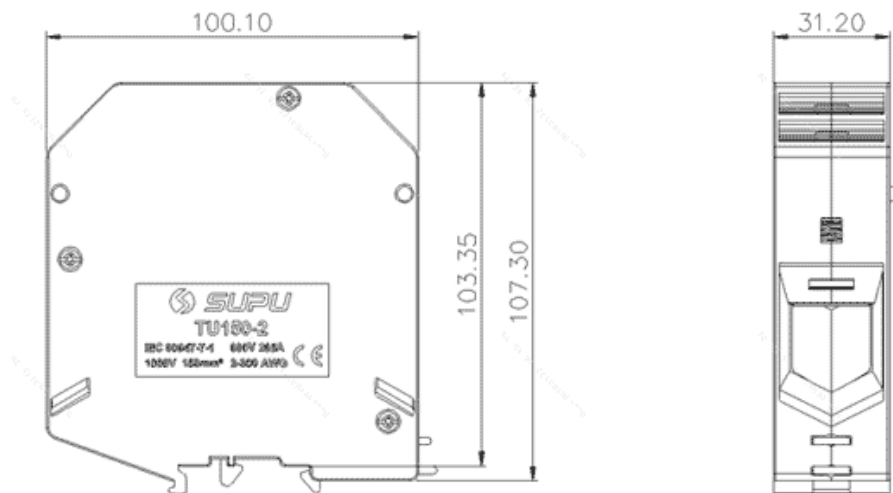

Parameters

⌘ SUPU ID	TU240-2-GY
⌘ Width	36mm
⌘ Number of levels	1
⌘ Number of connections	2

☞ Connection method	Screw connection
☞ Protection Level	IP20
☞ Insulation material	PA66
☞ Insulation material group	I
☞ Contact material	Copper alloy
☞ Contact plating	Sn,Plated
☞ Ambient temperature (operation)	-40°C~105°C
☞ Ambient temperature (assembly)	-5°C~70°C
☞ Ambient temperature (storage)	-25°C~60°C
☞ Permissible humidity (storage/transport)	30%~70%
☞ Product type	Terminal block of side-entry

Technical data

☞ IEC Rated Current	415A
☞ IEC Rated Voltage	1000V
☞ Overvoltage category	III
☞ Degree of pollution	3
☞ Rated impulse voltage	8kV
☞ UL Rated Current	380A
☞ UL Rated Voltage	600V
☞ Conductor cross section rigid	70-240mm ²
☞ Conductor cross section flexible	70-240mm ²
☞ Conductor cross section flexible,with ferrule	70-185mm ²
☞ Locking screw Specification	M10(hexagonal)

☞ Locking screw torque	20-30N.m
☞ Fixed Screw Specification	/
☞ 固定螺钉扭矩	/
☞ Stripping length	40mm
☞ Use group	B/C
☞ Rated cross section	2/0-500kcmil
☞ UL Rated Current	380A
☞ UL Rated Current	600V

Commercial data

☞ Order No	TU240-2-GY
------------	------------

Ningbo SUPU Electronics Co., Ltd.

Address: No. 150, Xinxing 4th Road, High-tech Industrial Development Zone,

Cixi City, Zhejiang Province, China

Zip code: 315303

Switchboard: +86 574-63288158

Fax: +86 574-63288170

E-mail:supucontact@supu.cn

Service Hotline: 400-626-6336



Date:2026-04-25 18:07

The right to modify data belongs to SUPU.