

Product Type: Screw terminal

Product Name:TUD4-2-PV

Product Description: Connection method:Screw connection,IEC Rated current:32A,IEC Rated Voltage:800V,Number of connections:4,Number of levels : 2,Rated cross section:26-10AWG

Product Size

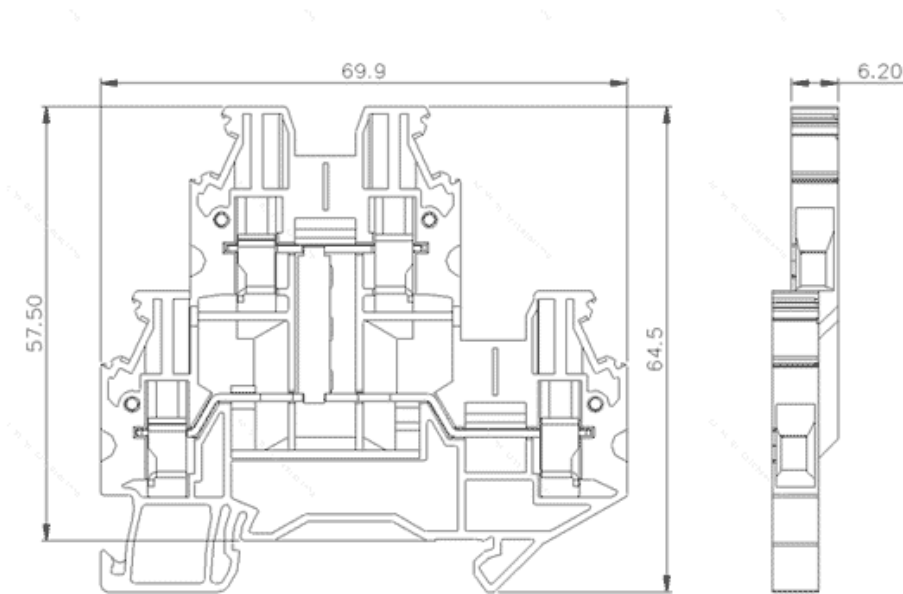

Parameters

☞ SUPU ID	TUD4-2-PV
☞ Width	6.2mm
☞ Number of levels	2
☞ Number of connections	4

☞ Connection method	Screw connection
☞ Protection Level	IP20
☞ Insulation material	PA66
☞ Insulation material group	I
☞ Contact material	Copper alloy
☞ Contact plating	Sn,Plated
☞ Ambient temperature (operation)	-40°C~105°C
☞ Ambient temperature (assembly)	-5°C~70°C
☞ Ambient temperature (storage)	-25°C~60°C
☞ Permissible humidity (storage/transport)	30%~70%
☞ Product type	Terminal block of side-entry

Technical data

☞ IEC Rated Current	32A
☞ IEC Rated Voltage	800V
☞ Overvoltage category	III
☞ Degree of pollution	3
☞ Rated impulse voltage	8kV
☞ UL Rated Current	30A
☞ UL Rated Voltage	600V
☞ Conductor cross section rigid	0.2-6mm ²
☞ Conductor cross section flexible	0.2-4mm ²
☞ Conductor cross section flexible,with ferrule	0.2-4mm ²
☞ Locking screw Specification	M3

☞ Locking screw torque	0.5N.m
☞ Fixed Screw Specification	/
☞ 固定螺钉扭矩	/
☞ Stripping length	9-11mm
☞ Use group	B/C
☞ Rated cross section	26-10AWG
☞ UL Rated Current	30A
☞ UL Rated Current	600V

Commercial data

☞ Order No	TUD4-2-PV
------------	-----------

Ningbo SUPU Electronics Co., Ltd.

Address: No. 150, Xinxing 4th Road, High-tech Industrial Development Zone,

Cixi City, Zhejiang Province, China

Zip code: 315303

Switchboard: +86 574-63288158

Fax: +86 574-63288170

E-mail:supucontact@supu.cn

Service Hotline: 400-626-6336



Date:2026-05-02 08:53

The right to modify data belongs to SUPU.