

Product Type: Screw terminal

Product Name:310921

Product Description: Connection method:Screw connection,IEC Rated current:57A,IEC Rated Voltage:500V,Number of connections:4,Number of levels : 2,Rated cross section:24-6AWG

Product Size

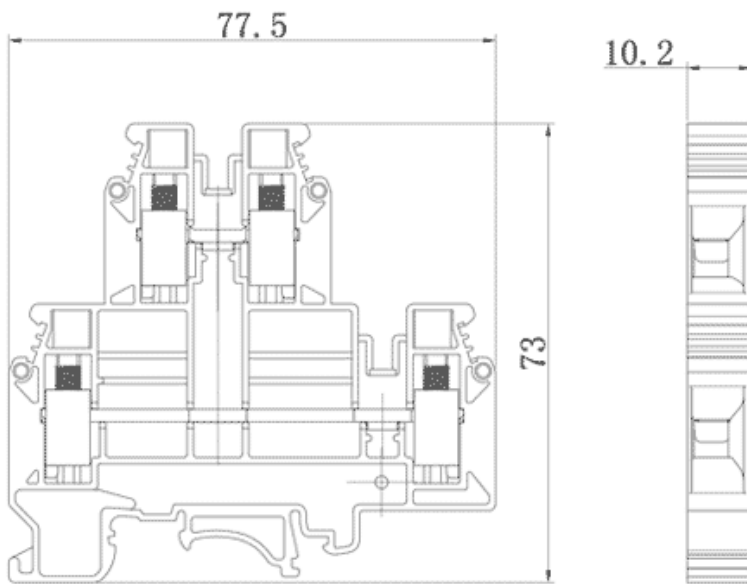

Parameters

☞ SUPU ID	310921
☞ Width	10.2mm
☞ Number of levels	2
☞ Number of connections	4

☞ Connection method	Screw connection
☞ Protection Level	IP20
☞ Insulation material	PA66
☞ Insulation material group	I
☞ Contact material	Copper
☞ Contact plating	Ni,Plated
☞ Ambient temperature (operation)	-40°C~105°C
☞ Ambient temperature (assembly)	-5°C~70°C
☞ Ambient temperature (storage)	-25°C~60°C
☞ Permissible humidity (storage/transport)	30%~70%
☞ Product type	Terminal block of side-entry

Technical data

☞ IEC Rated Current	57A
☞ IEC Rated Voltage	500V
☞ Overvoltage category	III
☞ Degree of pollution	3
☞ Rated impulse voltage	6kV
☞ UL Rated Current	65A
☞ UL Rated Voltage	600V
☞ Conductor cross section rigid	0.5-10mm ²
☞ Conductor cross section flexible	0.5-10mm ²
☞ Conductor cross section flexible,with ferrule	0.5-10mm ²
☞ Locking screw Specification	M4

☞ Locking screw torque	1.5N.m
☞ Fixed Screw Specification	/
☞ 固定螺钉扭矩	/
☞ Stripping length	11-12mm
☞ Use group	B/C
☞ Rated cross section	24-6AWG
☞ UL Rated Current	65A
☞ UL Rated Current	600V

Commercial data

☞ Order No	310921
------------	--------

Ningbo SUPU Electronics Co., Ltd.

Address: No. 150, Xinxing 4th Road, High-tech Industrial Development Zone,

Cixi City, Zhejiang Province, China

Zip code: 315303

Switchboard: +86 574-63288158

Fax: +86 574-63288170

E-mail:supucontact@supu.cn

Service Hotline: 400-626-6336



Date:2026-04-29 13:47

The right to modify data belongs to SUPU.