

Product Type: Plug-in terminal-Socket

Product Name:MC-PH7.62H07-0001

Product Description: Pitch: 7.62mm Rated Voltage : 630V Rated Current: 32A colour : customizable

Product Size

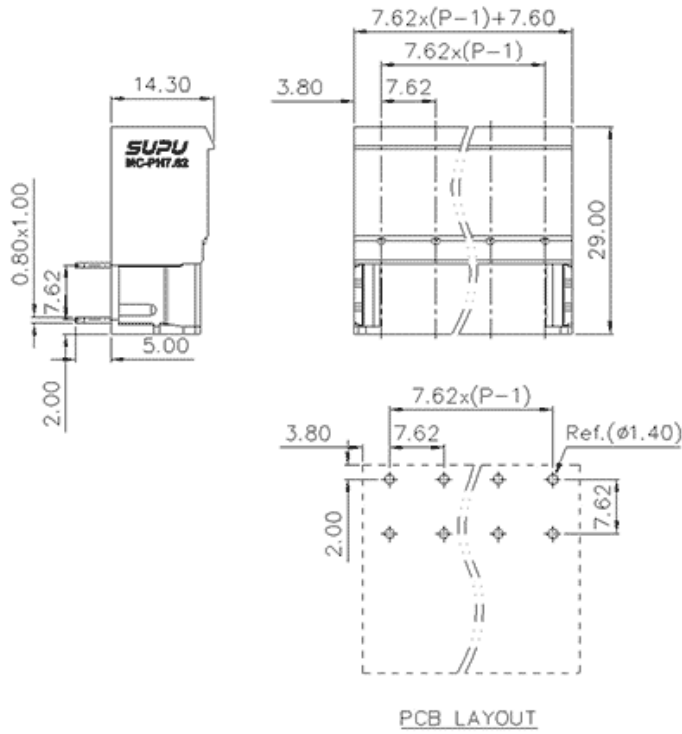

Parameters

⌘ SUPU ID	MC-PH7.62H07-0001
⌘ Pitch	7.62
⌘ Number of levels	Single layer
⌘ Number of connections	7

☞ Connection method	-
☞ Protection Level	IP20
☞ Operating temperature range	-40~+105°C
☞ Insulation material	PA66
☞ Insulation material group	I
☞ Contact material	Copper alloy
☞ Contact plating	Sn,Plated
☞ Color	Green/Black/Blue/Grey/Orange/Red

Technical data

☞ IEC Rated Current	630V
☞ IEC Rated Voltage	32A
☞ Overvoltage category	III III II
☞ Degree of pollution	3 2 2
☞ Rated impulse voltage	6.0KV 6.0KV 6.0KV
☞ UL Rated Current	20A 20A -
☞ UL Rated Voltage	300V 300V -
☞ Use group	B/C/D

Commercial data

☞ Order No	MC-PH7.62H07-0001
------------	-------------------

Ningbo SUPU Electronics Co., Ltd.

Address: No. 150, Xinxing 4th Road, High-tech Industrial Development Zone,

Cixi City, Zhejiang Province, China

Zip code: 315303

Switchboard: +86 574-63288158

Fax: +86 574-63288170

E-mail:supucontact@supu.cn

Service Hotline: 400-626-6336



Wechat

Date:2026-04-25 19:19

The right to modify data belongs to SUPU.