

Product Type: Plug-in terminal-Plug

Product Name:MC-RE5.08V08C-0001

Product Description: Pitch:5.0mm Rated Voltage : 320V Rated Current:12A Connection method : Screw connection colour : customizable

Product Size

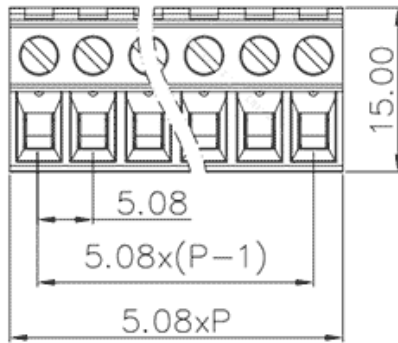
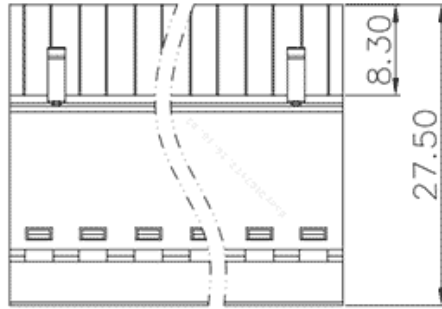

Parameters

⌘ SUPU ID	MC-RE5.08V08C-0001
⌘ Pitch	5.08
⌘ Number of levels	single layer
⌘ Number of connections	8

☞ Connection method	Screw connection
☞ Protection Level	IP20
☞ Operating temperature range	-40~+105°C
☞ Insulation material	PA66
☞ Insulation material group	I
☞ Contact material	Copper alloy
☞ Contact plating	Sn,Plated
☞ Color	Green/Black/Blue/Grey/Orange/Red

Technical data

☞ IEC Rated Current	12A
☞ IEC Rated Voltage	320V
☞ Overvoltage category	III/III/ II
☞ Degree of pollution	3 2 2
☞ Rated impulse voltage	4.0KV 4.0KV4.0KV
☞ UL Rated Current	15A - 10A
☞ UL Rated Voltage	300V - 300V
☞ Conductor cross section rigid	0.2-2.5mm ²
☞ Conductor cross section flexible	0.2-2.5mm ²
☞ Conductor cross section flexible,with furrule	0.2-2.5mm ²
☞ Locking screw Specification	M3
☞ Locking screw torque	0.5N.m
☞ Fixed Screw Specification	-
☞ 固定螺钉扭矩	-

☞ Stripping length	7~8mm
☞ Use group	B/C/D
☞ Rated cross section	24~12AWG

Commercial data

☞ Order No	MC-RE5.08V08C-0001
------------	--------------------

Ningbo SUPU Electronics Co., Ltd.

Address: No. 150, Xinxing 4th Road, High-tech Industrial Development Zone,
Cixi City, Zhejiang Province, China

Zip code: 315303

Switchboard: +86 574-63288158

Fax: +86 574-63288170

E-mail:supucontact@supu.cn

Service Hotline: 400-626-6336



Wechat