

Product Type: Plug-in terminal-Plug

Product Name:MC-

RHH7.62H06C-0001

Product Description: Pitch:7.62mm Rated

Voltage : 1000V Rated Current:41A Connection

method : Screw connection colour : customizable

Product Size

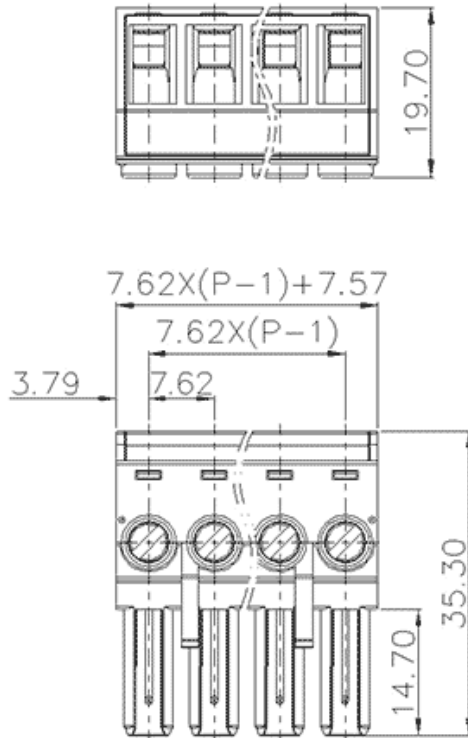

Parameters

⌘ SUPU ID	MC-RHH7.62H06C-0001
⌘ Pitch	7.62
⌘ Number of levels	single layer
⌘ Number of connections	6

☞ Connection method	Screw connection
☞ Protection Level	IP20
☞ Operating temperature range	-40~+105°C
☞ Insulation material	PA66
☞ Insulation material group	I
☞ Contact material	Copper alloy
☞ Contact plating	Sn,Plated
☞ Color	Green/Black/Blue/Grey/Orange/Red

## Technical data

☞ IEC Rated Current	41A
☞ IEC Rated Voltage	1000V
☞ Overvoltage category	III/III/ II
☞ Degree of pollution	3 2 2
☞ Rated impulse voltage	8.0KV 8.0KV8.0KV
☞ UL Rated Current	41A 41A -
☞ UL Rated Voltage	600V 600V -
☞ Conductor cross section rigid	0.2-6mm <sup>2</sup>
☞ Conductor cross section flexible	0.2-6mm <sup>2</sup>
☞ Conductor cross section flexible,with furrule	0.2-6mm <sup>2</sup>
☞ Locking screw Specification	M3
☞ Locking screw torque	0.5N.m
☞ Fixed Screw Specification	-
☞ 固定螺钉扭矩	-

☞ Stripping length	10-11mm
☞ Use group	B/C/D
☞ Rated cross section	24~8AWG

## Commercial data

☞ Order No	MC-RHH7.62H06C-0001
------------	---------------------

### Ningbo SUPU Electronics Co., Ltd.

Address: No. 150, Xinxing 4th Road, High-tech Industrial Development Zone,  
Cixi City, Zhejiang Province, China

Zip code: 315303

Switchboard: +86 574-63288158

Fax: +86 574-63288170

E-mail:supucontact@supu.cn

Service Hotline: 400-626-6336



Wechat