

Product Type: Plug-in terminal-Plug

Product Name:MC-RJ5.08H12P-D-0001

Product Description: Pitch:5.08mm Rated Voltage : 320V Rated Current:12A Connection method : Push-in spring connection colour : customizable

Product Size

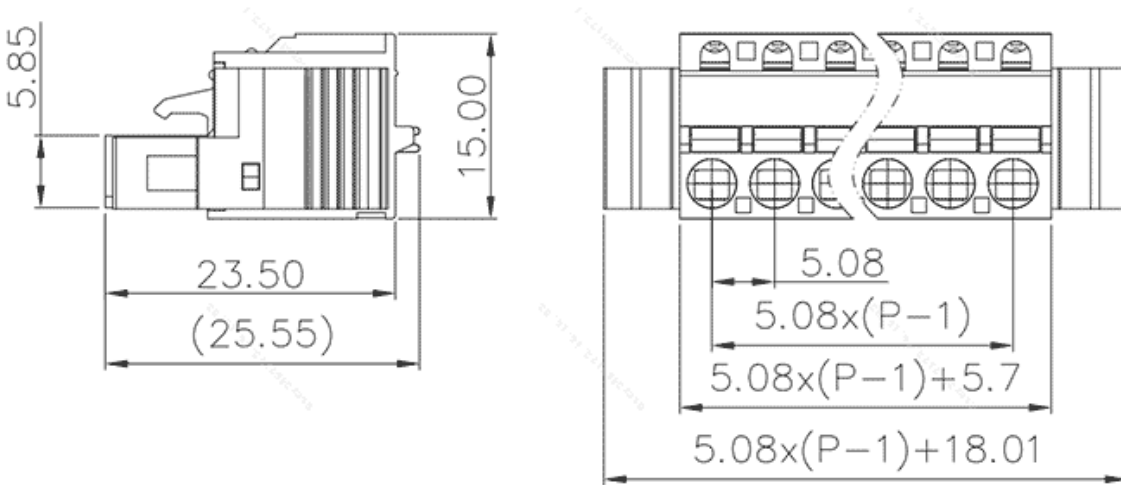

Parameters

| | |
|-------------------------|----------------------|
| ⌘ SUPU ID | MC-RJ5.08H12P-D-0001 |
| ⌘ Pitch | 5.08 |
| ⌘ Number of levels | single layer |
| ⌘ Number of connections | 12 |

| | |
|-------------------------------|----------------------------------|
| ☞ Connection method | Push in connection |
| ☞ Protection Level | IP20 |
| ☞ Operating temperature range | -40~+105°C |
| ☞ Insulation material | PA66 |
| ☞ Insulation material group | I |
| ☞ Contact material | Copper alloy |
| ☞ Contact plating | Sn,Plated |
| ☞ Color | Green/Black/Blue/Grey/Orange/Red |

Technical data

| | |
|---|------------------------|
| ☞ IEC Rated Current | 12A |
| ☞ IEC Rated Voltage | 320V |
| ☞ Overvoltage category | III/III/ II |
| ☞ Degree of pollution | 3 2 2 |
| ☞ Rated impulse voltage | 4.0KV 4.0KV4.0KV |
| ☞ UL Rated Current | 10A - 10A |
| ☞ UL Rated Voltage | 300V - 300V |
| ☞ Conductor cross section rigid | 0.2-2.5mm ² |
| ☞ Conductor cross section flexible | 0.2-2.5mm ² |
| ☞ Conductor cross section flexible,with furrule | 0.2-2.5mm ² |
| ☞ Locking screw Specification | - |
| ☞ Locking screw torque | - |
| ☞ Fixed Screw Specification | - |
| ☞ 固定螺钉扭矩 | - |

| | |
|-----------------------|----------|
| ☞ Stripping length | 10-11mm |
| ☞ Use group | B/C/D |
| ☞ Rated cross section | 24~12AWG |

Commercial data

| | |
|------------|----------------------|
| ☞ Order No | MC-RJ5.08H12P-D-0001 |
|------------|----------------------|

Ningbo SUPU Electronics Co., Ltd.

Address: No. 150, Xinxing 4th Road, High-tech Industrial Development Zone,
Cixi City, Zhejiang Province, China

Zip code: 315303

Switchboard: +86 574-63288158

Fax: +86 574-63288170

E-mail:supucontact@supu.cn

Service Hotline: 400-626-6336



Wechat