

Product Type: Quick plug connector

## Product Name:ESF-RS250A20BB2Q

Product Description: Connectors suitable for energy storage modules: Color: Black Wire cross-section: 70mm<sup>2</sup> Rated voltage: 1500V DC Rated current: 250A (70mm<sup>2</sup>) Connection method: screw Contact type: Spring

### Product Size

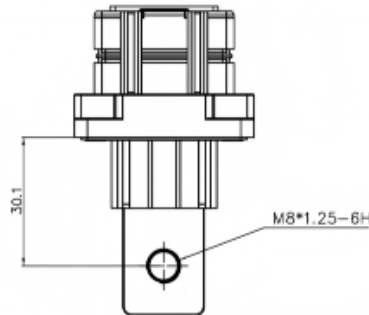
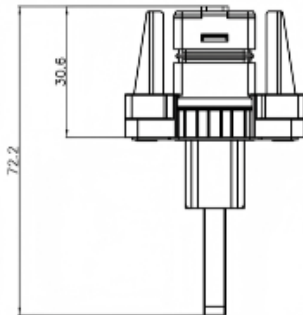
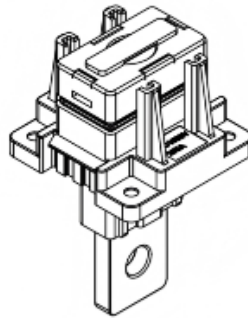
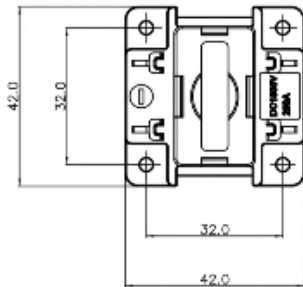

### Parameters

☞ SUPU ID

ESF-RS250A20BB2Q

☞ Connection method

Screw thread

☞ Protection Level

IP67

☞ Operating temperature range	-40°C~125°C
☞ Insulation material	PA
☞ Insulation material group	III
☞ Contact material	Copper alloy
☞ Contact plating	Ag,Plated
☞ Insertion/withdrawal cycles	100
☞ Insertion force	≤75N
☞ Withdrawal force	≥10N

## Technical data

☞ Rated Voltage	1500V
☞ Overvoltage category	III
☞ Degree of pollution	3
☞ Rated impulse voltage	12.3KV
☞ Rated cross section	70mm <sup>2</sup> ( AWG2/0)
☞ Rated cross section(AWG)	AWG2/0

## Commercial data

☞ Order No	ESF-RS250A20BB2Q
☞ Packing unit	PCS
☞ Minimum order quantity	1
☞ Weight per unit (without packaging)	0.089KG
☞ Single piece weight	0.087KG

## Ningbo SUPU Electronics Co., Ltd.

Address: No. 150, Xinxing 4th Road, High-tech Industrial Development Zone,  
Cixi City, Zhejiang Province, China

Zip code: 315303

Switchboard: +86 574-63288158

Fax: +86 574-63288170

E-mail:supucontact@supu.cn

Service Hotline: 400-626-6336



Wechat

---

Date:2026-04-27 20:58

The right to modify data belongs to SUPU.