

Product Type: Quick plug connector

Product Name:ESF-
RS250A20YB2Q

Product Description: Connectors suitable for energy storage modules: Color: Orange Wire cross-section: 70mm² Rated voltage: 1500V DC Rated current: 250A (70mm²) Connection method: screw Contact type: Spring

Product Size

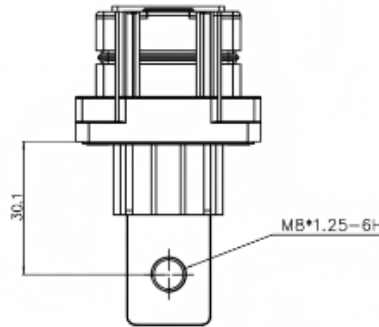
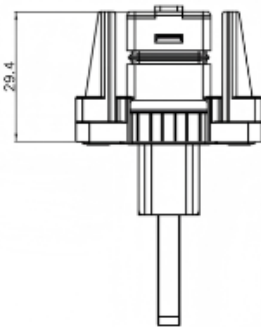
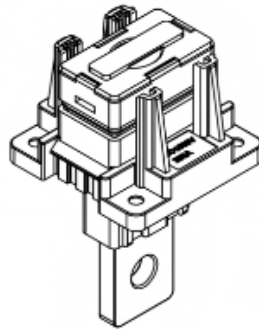
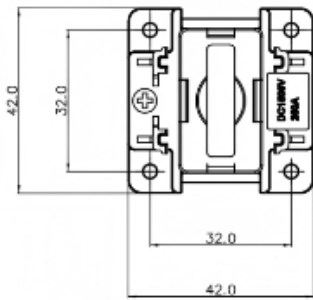

Parameters

<p>⌘ SUPU ID</p>	<p>ESF-RS250A20YB2Q</p>
<p>⌘ Connection method</p>	<p>Screw thread</p>
<p>⌘ Protection Level</p>	<p>IP67</p>

☞ Operating temperature range	-40°C~125°C
☞ Insulation material	PA
☞ Insulation material group	III
☞ Contact material	Copper alloy
☞ Contact plating	Ag,Plated
☞ Insertion/withdrawal cycles	100
☞ Insertion force	≤75N
☞ Withdrawal force	≥10N

Technical data

☞ Rated Voltage	1500V
☞ Overvoltage category	III
☞ Degree of pollution	3
☞ Rated impulse voltage	12.3KV
☞ Rated cross section	70mm ² (AWG2/0)
☞ Rated cross section(AWG)	AWG2/0

Commercial data

☞ Order No	ESF-RS250A20YB2Q
☞ Packing unit	PCS
☞ Minimum order quantity	1
☞ Weight per unit (without packaging)	0.089KG
☞ Single piece weight	0.087KG

Ningbo SUPU Electronics Co., Ltd.

Address: No. 150, Xinxing 4th Road, High-tech Industrial Development Zone,
Cixi City, Zhejiang Province, China

Zip code: 315303

Switchboard: +86 574-63288158

Fax: +86 574-63288170

E-mail:supucontact@supu.cn

Service Hotline: 400-626-6336



Wechat

Date:2026-04-27 18:16

The right to modify data belongs to SUPU.